

**FIND THE MATCH**

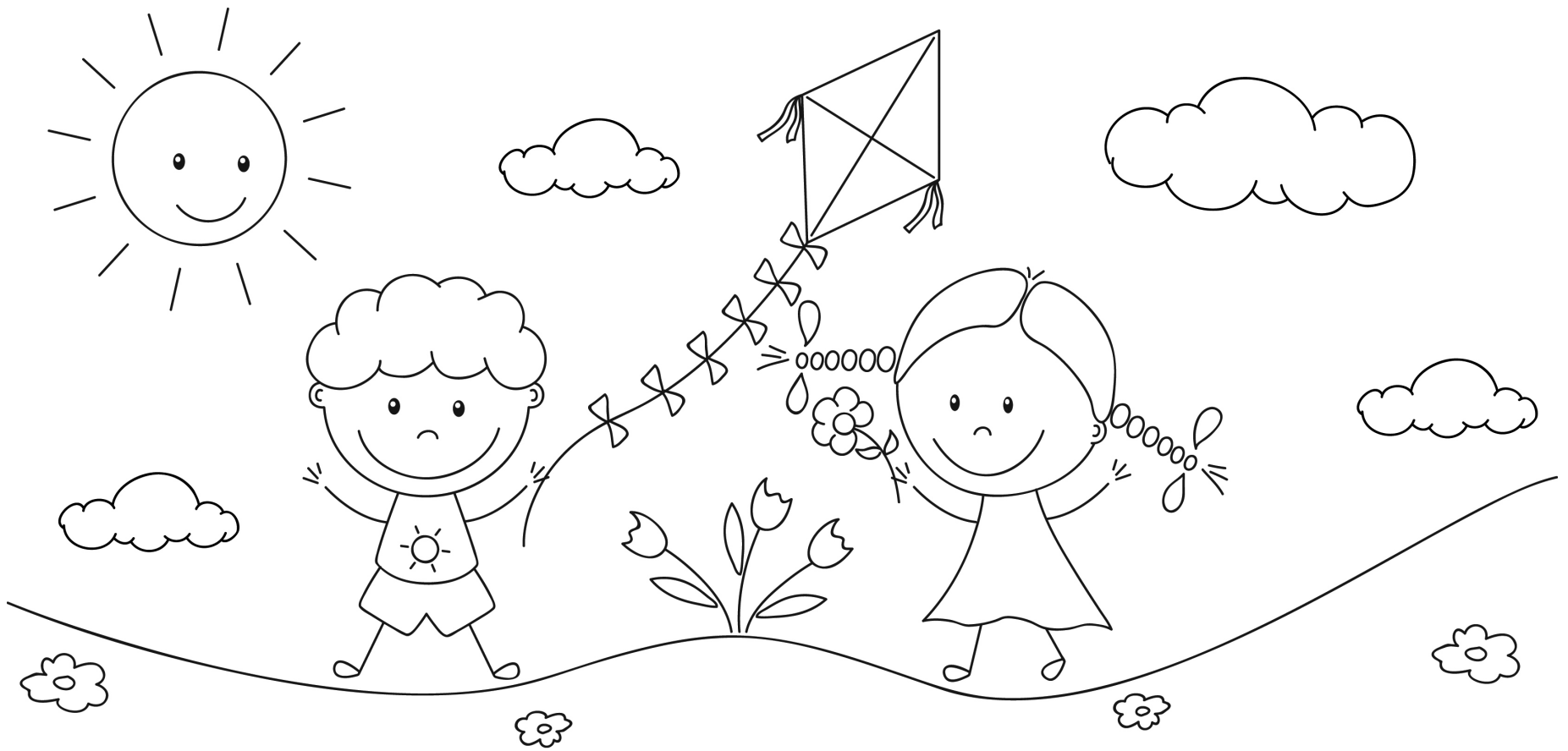

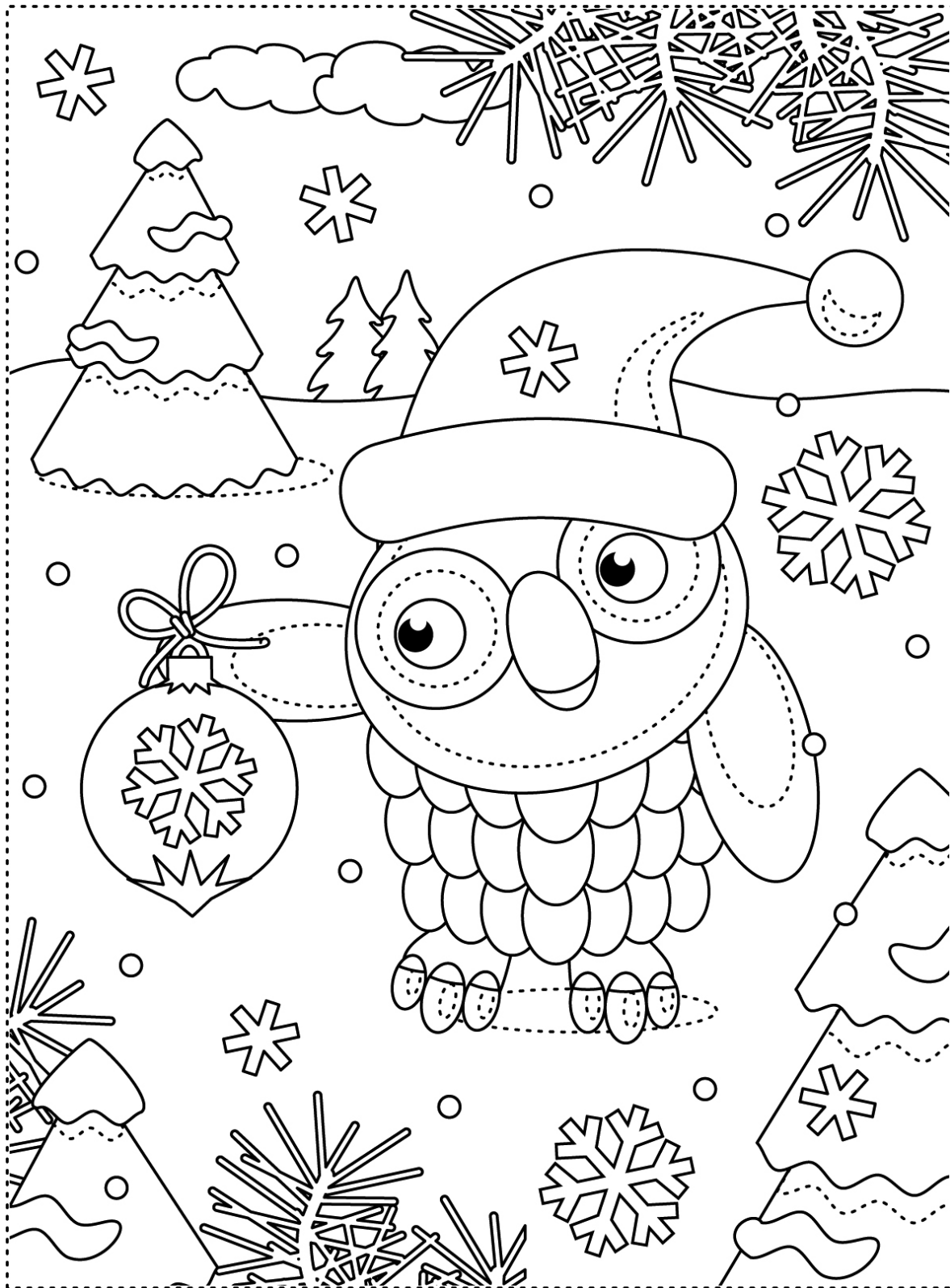

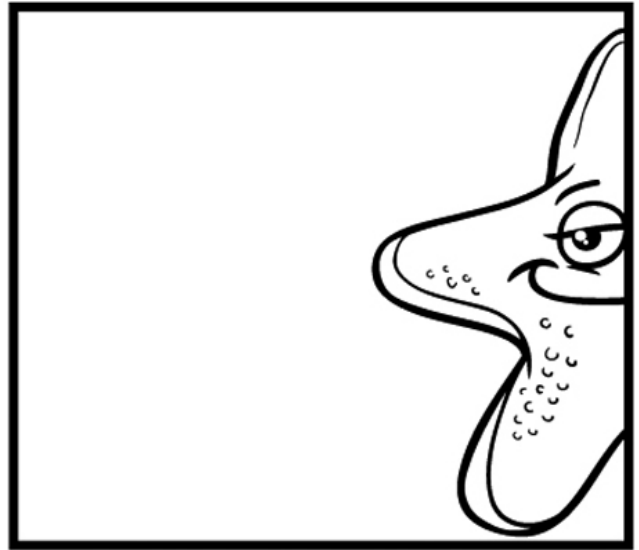
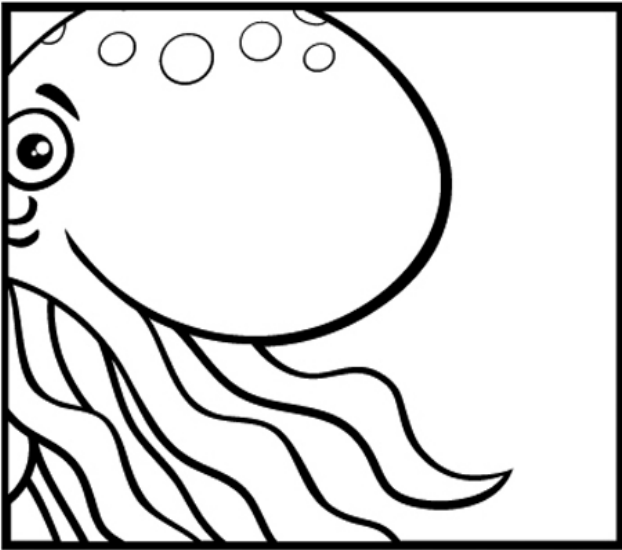
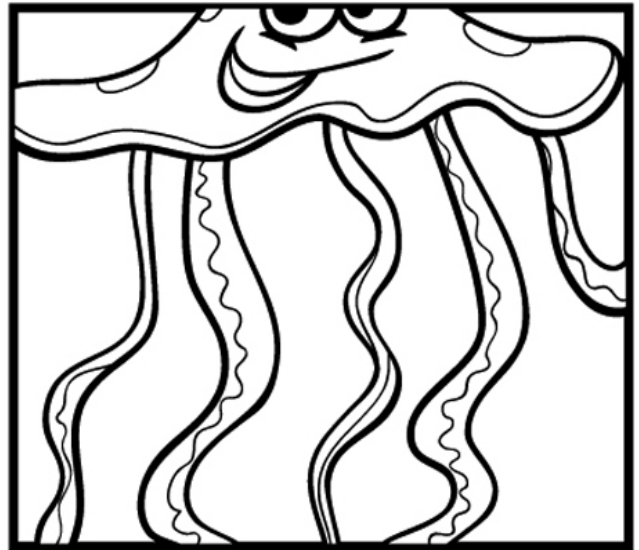
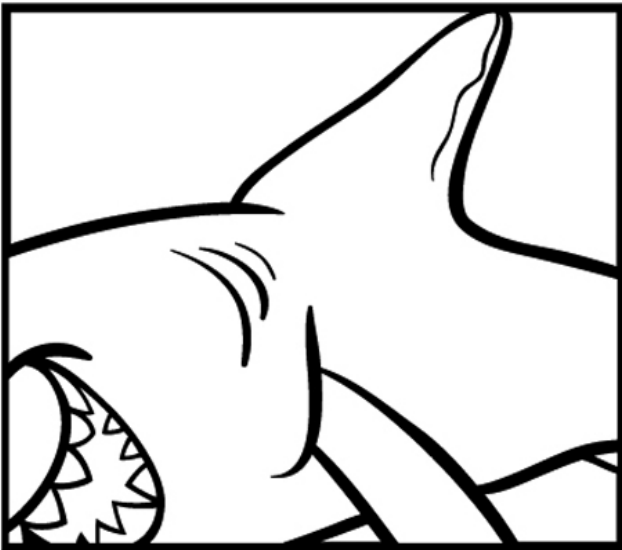

**CAN YOU GUESS THE ANIMAL?**

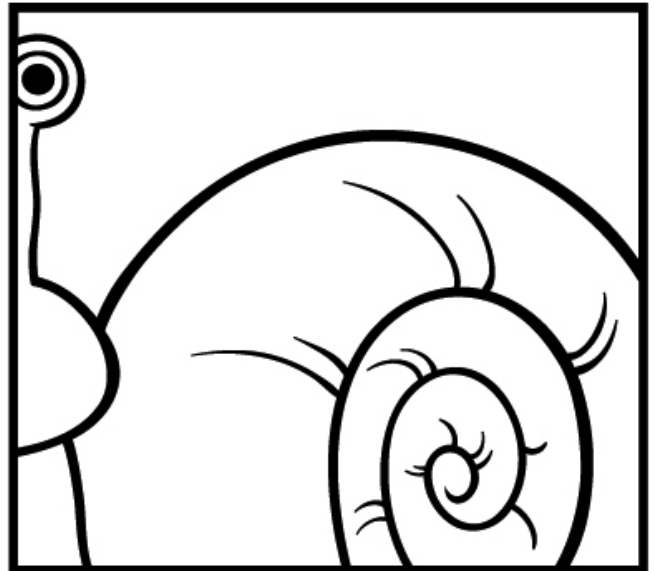
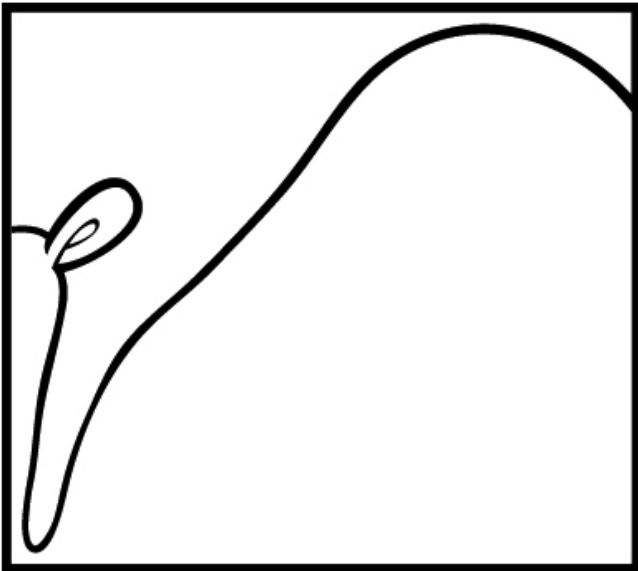
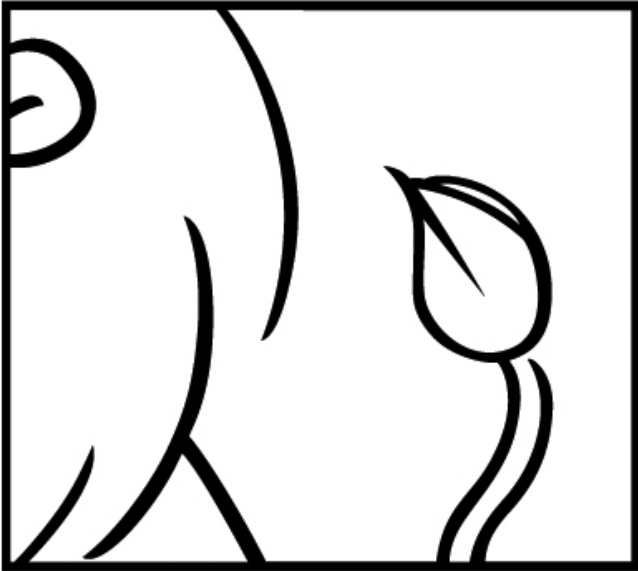

**CAN YOU GUESS THE ANIMAL?**

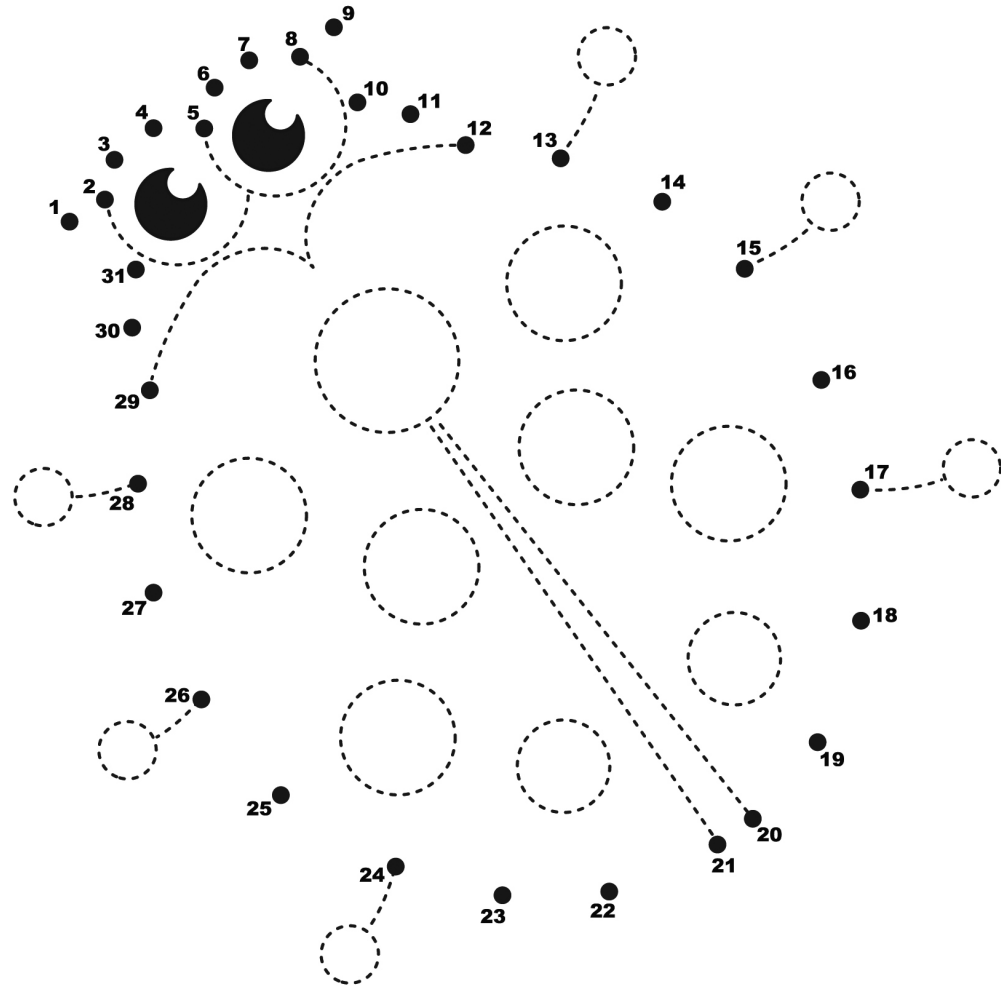
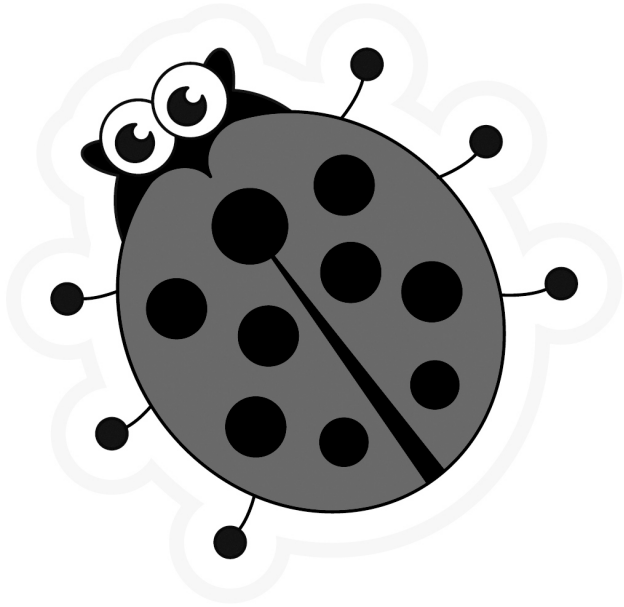

**CONNECT THE NUMBERS  
IN THE CORRECT ORDER**

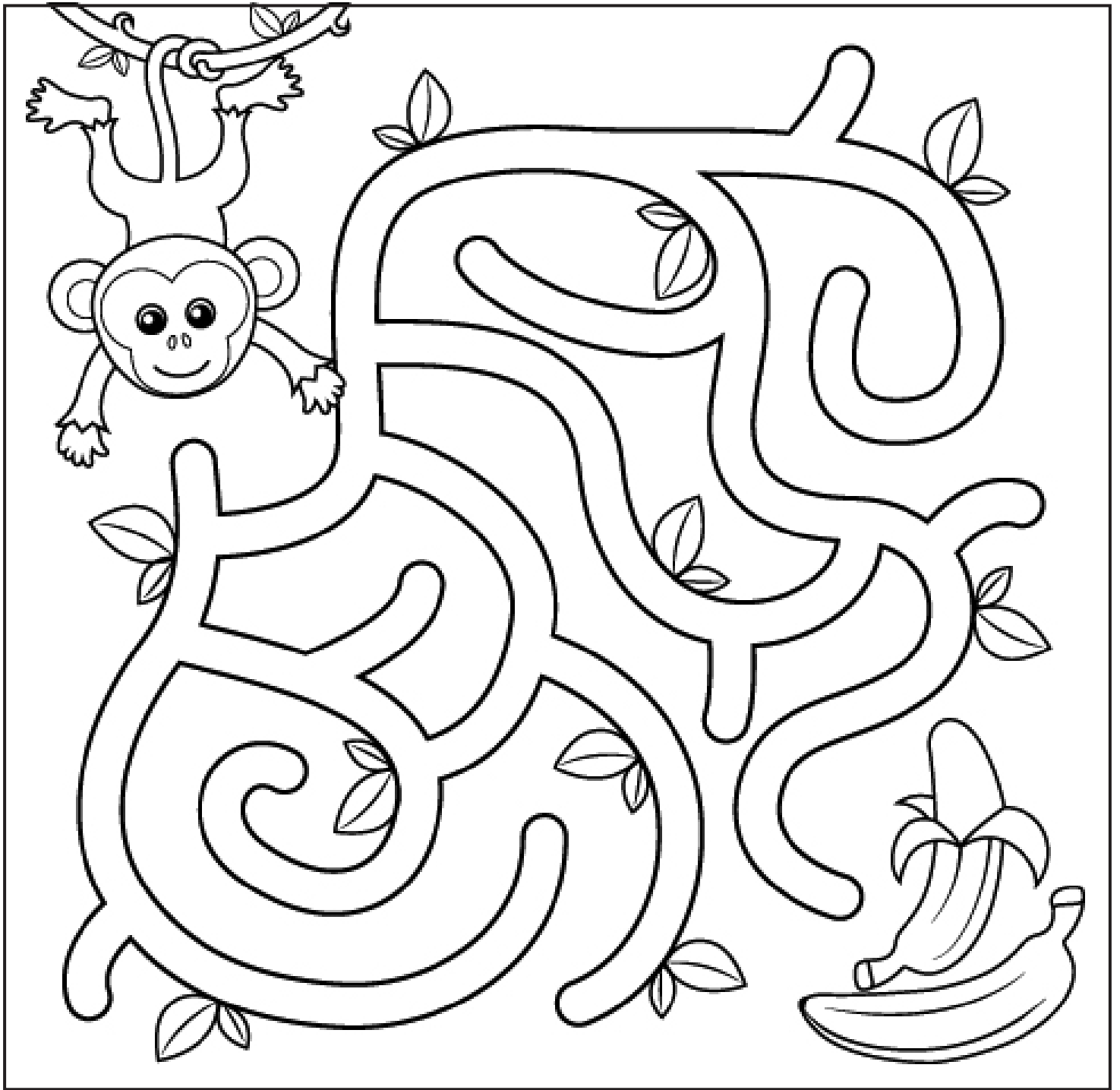

**HELP THE MONKEY FIND THE BANANA**

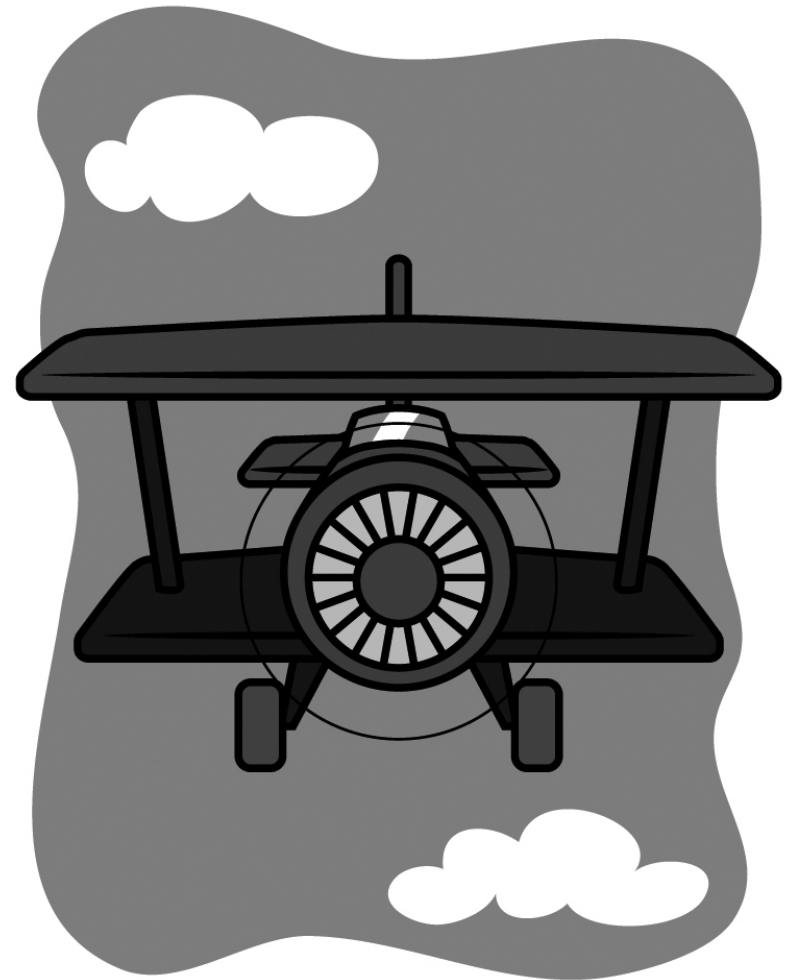
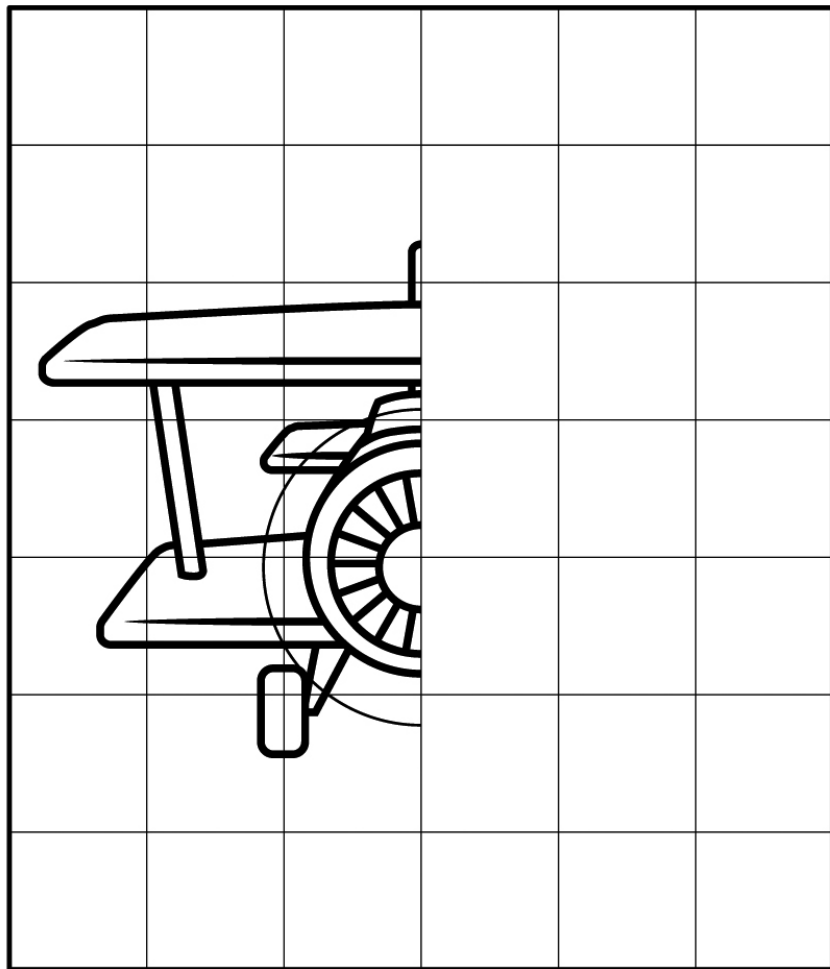

**COMPLETE THE PICTURE**



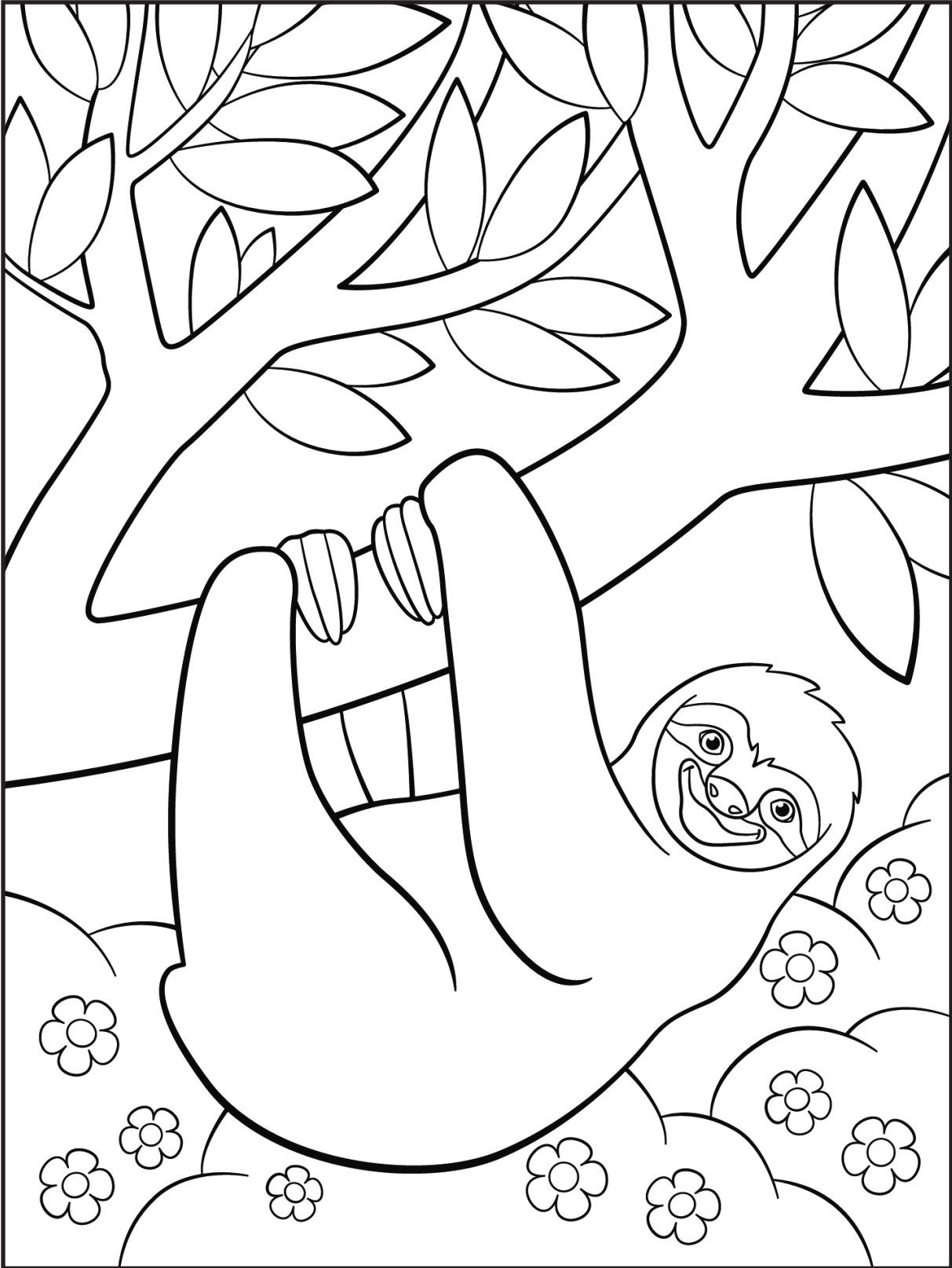

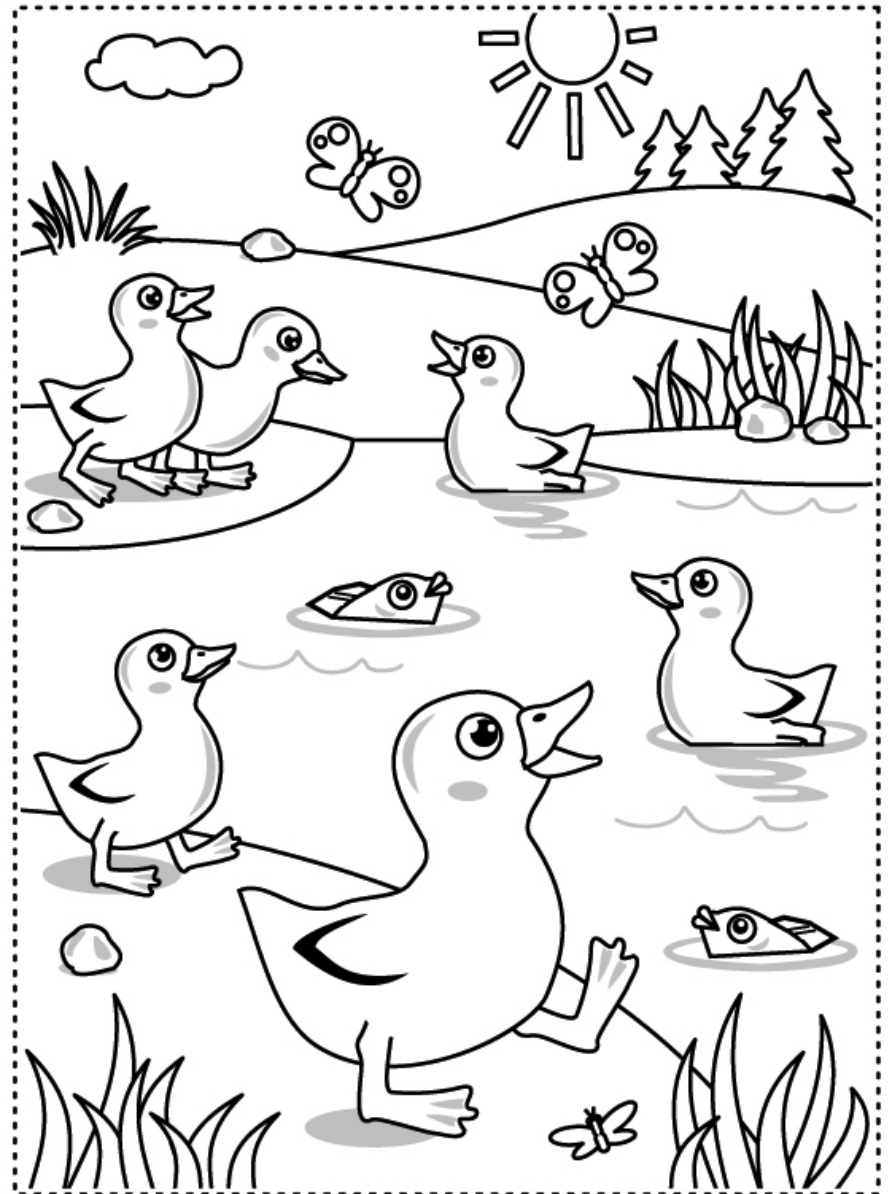
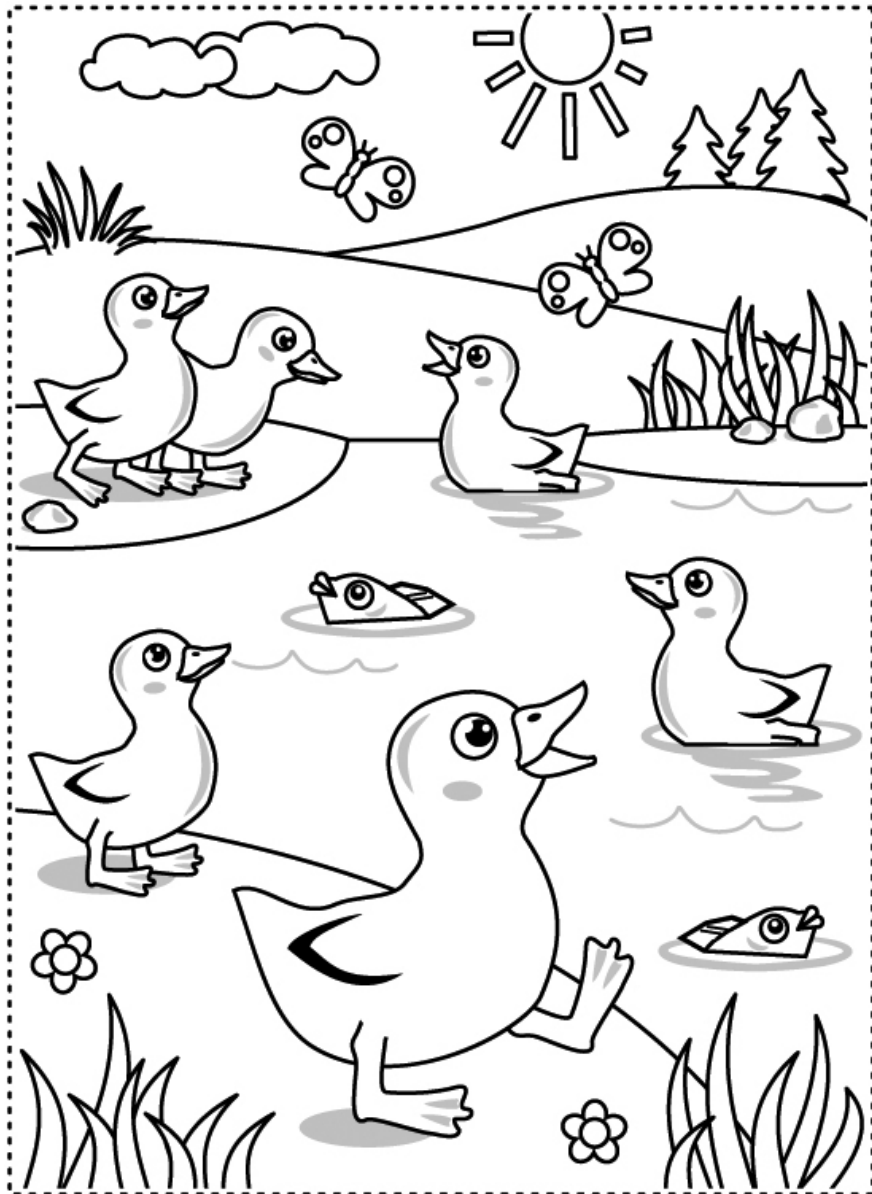

**FIND THE TEN DIFFERENCES BETWEEN THESE TWO PICTURES**



